



Staffe di sostegno per lapidi (modello "Staffa compatta")

Support brackets for tombstones (model "Compact Bracket")

Etriers de supports pour pierres tombales (modèle "Etrier Compact")

Specifiche tecniche / Technical specifications/ Spécifications techniques

H1	8 cm
H2	19 cm
L1	2,5 cm
L2	5 cm
S	0,8 ÷ 2 cm
P	3 cm
M	8 mm

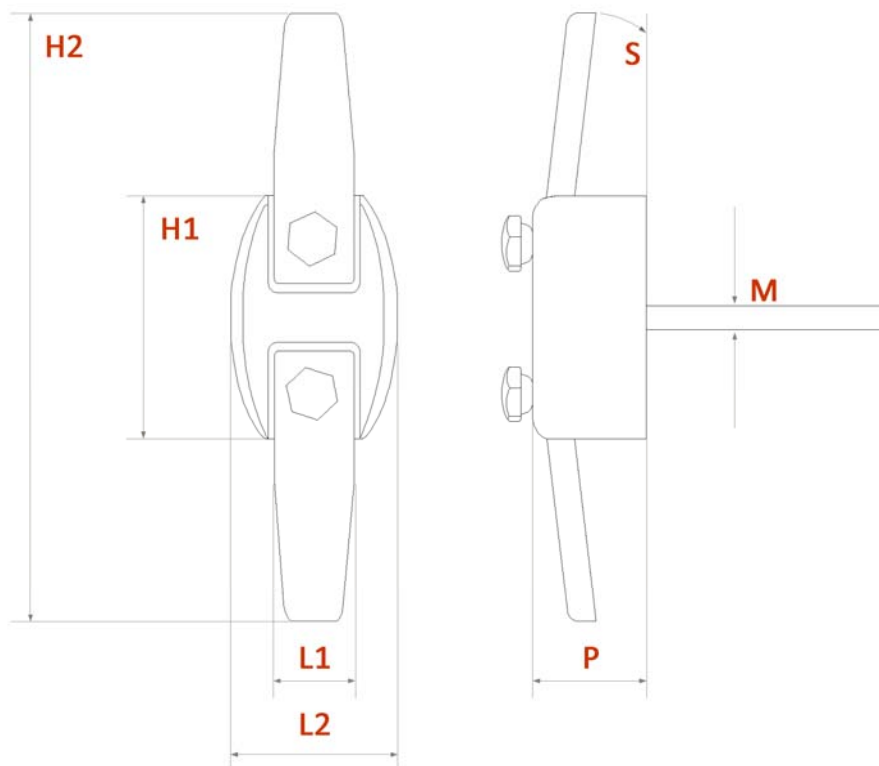

Articoli con queste specifiche / Items with these specs / Articles avec ces specs

Codice / Code	Misure / Sizes / Mesures	Colore / Colour / Couleur
P.10.2797/8	cm 8x19 M8	Bronzo / Bronze